

Article number: 07122400001

Description: Universal joint single 0.122.400.001  
S=220 X= Bore with keyway

## Measures

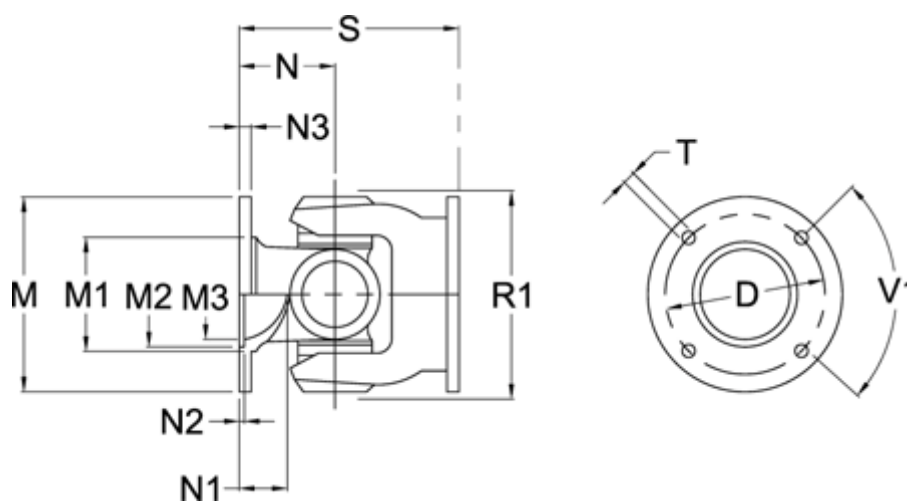

D	= 155,5 $\pm$ 0,1	N2	= 3,6 $\pm$ 0,5
Flange diameter M	= 180	N3	= 15
M1	= 118	Number of Flangeholes	= 10
M2	= 110	R1	= 204
M3	= 98	S min	= 220
Max. Bending Angle degrees	= 30	T	= 16 B12
N	= 110	V1 degrees	= 36
N1	= 36		